

# Flow-to-Wire In-Conduit Hydropower Turbine

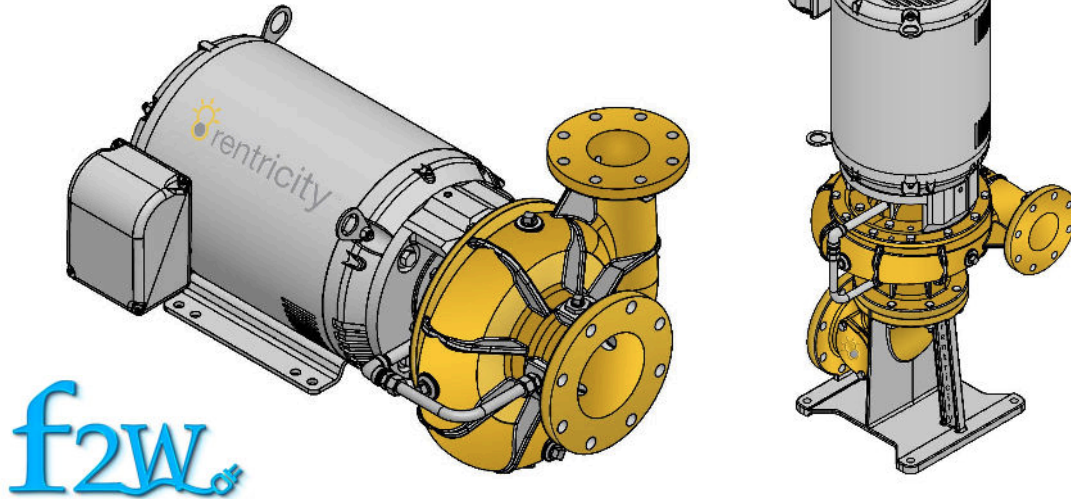

**Model: 4TR2 – 1800 rpm**  
**Output Range: 5 to 60kW**



Standard Integrated Configuration	
<b>Turbine</b>	Ductile Iron/Close Coupled
<b>Seal</b>	Mechanical Shaft Seal
<b>Generator</b>	Standard Open Drip Proof (ODP) 480 volt - 3 phase

Optional Features
Safe Water/Low Lead NSF 61/372 Certification
Horizontal (frame mount) or Vertical (support stand) Configuration
Stainless Steel
Total Enclosed Fan-Cooled Generator (TEFC)
Fresh Water/Finished Consumable Water
Single phase, 600 volt 3 phase generators
1200 and 1800 RPM generators
Speed Sensing (Tachometer)