

Flow-to-Wire In-Conduit Hydropower Turbine

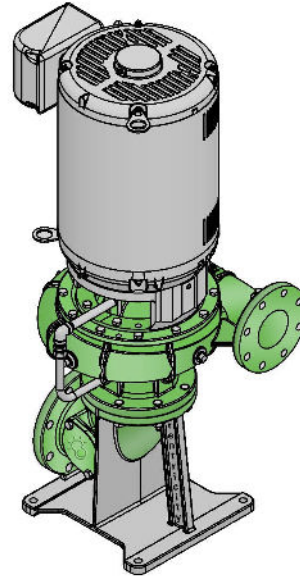

Model: 4TR4 – 1800 rpm
Output Range: 15 to 80kW

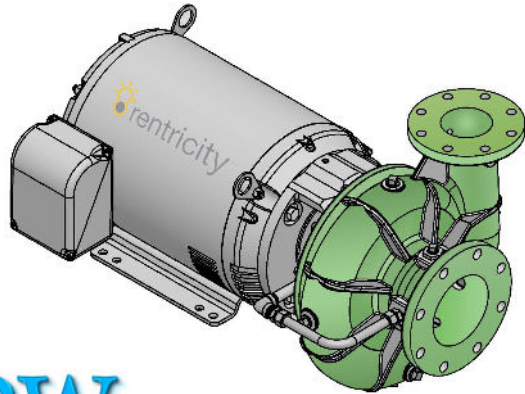

f2w

Standard Integrated Configuration	
Turbine	Ductile Iron/Close Coupled
Seal	Mechanical Shaft Seal
Generator	Standard Open Drip Proof (ODP) 480 volt - 3 phase

Optional Features
Safe Water/Low Lead NSF 61/372 Certification
Horizontal (frame mount) or Vertical (support stand) Configuration
Stainless Steel
Total Enclosed Fan-Cooled Generator (TEFC)
Fresh Water/Finished Consumable Water
Single phase, 600 volt 3 phase generators
1200 and 1800 RPM generators
Speed Sensing (Tachometer)

Contact: info@reentricity.com

www.reentricity.com

(732) 319-4501